

# Mixing Metering Handwash Faucet

**TECK<sup>®</sup>**  
COMMERCIAL

**DELTA<sup>®</sup>**

**Specification: (example)**

- **HEAVY-DUTY CAST BRASS**
- Two handle mixing metering faucet
- Vandal resistant handle actuator
- Vandal resistant spout outlet
- Polished chrome plated finish
- Delta<sup>®</sup> metering slow close cartridge
- **Total flow not to exceed 0.25 gallon per handle activation**

and ...  
with ... (add product variation required)  
with ... (add outlet required)  
with ... (add handle required)



**86T1153**

**Engineer/Architect Approval**





Model Specified:

Approval:

Date:

DESCRIPTION	PRODUCT NO.
Mixing Metering Handwash Faucet	86T1



PRODUCT VARIATION	OUTLET	HANDLE
<b>0</b> 102mm (4") Centerset with Open Grid Strainer  <input type="checkbox"/>	<b>0</b> <input type="checkbox"/>	<b>0</b> <input type="checkbox"/>
<b>1</b> 102mm (4") Centerset less Pop-up  <input type="checkbox"/>	<b>1</b> <input type="checkbox"/>	<b>1</b> <input type="checkbox"/>
<b>2</b> <input type="checkbox"/>	<b>2</b> <input type="checkbox"/>	<b>2</b> <input type="checkbox"/>
<b>3</b> <input type="checkbox"/>	<b>3</b> <input type="checkbox"/>	<b>3</b> Vandal Resistant ADA Lever Handle  <input type="checkbox"/>
<b>4</b> <input type="checkbox"/>	<b>4</b> <input type="checkbox"/>	<b>4</b> <input type="checkbox"/>
<b>5</b> <input type="checkbox"/>	<b>5</b> Vandal Resistant 0.5 gpm (1.9 L/min) Non-Aerating Spray Outlet  <input type="checkbox"/>	<b>5</b> <input type="checkbox"/>
<b>6</b> <input type="checkbox"/>	<b>6</b> <input type="checkbox"/>	<b>6</b> <input type="checkbox"/>
<b>7</b> <input type="checkbox"/>	<b>7</b> <input type="checkbox"/>	<b>7</b> <input type="checkbox"/>
<b>8</b> <input type="checkbox"/>	<b>8</b> <input type="checkbox"/>	<b>8</b> <input type="checkbox"/>
<b>9</b> <input type="checkbox"/>	<b>9</b> Vandal Resistant 0.35 gpm (1.32 L/min) Non-Aerating Spray Outlet  <input type="checkbox"/>	<b>9</b> <input type="checkbox"/>

Refer to [www.specselect.com](http://www.specselect.com) for individual models.

Flow Rates are at 60 PSI.  
Note: Use this page front and back as a product submittal sheet.

Delta reserves the right (1) to make changes in specifications and materials, and (2) to change or discontinue models, both without notice or obligation. Dimensions are for reference only. See current full-line price book or [www.specselect.com](http://www.specselect.com) for finish options and product availability.

DSP-86T Rev. E



**TECK<sup>®</sup>**  
COMMERCIAL

# Mixing Metering Handwash Faucet

**Approvals:**

- CSA certified
- Complies to ASME A112.18.1/CSA B125.1
- Indicates compliance to ICC/ANSI A117.1
- Verified compliant with 0.25% weighted average Pb content regulation

(Contact Delta Representative for State and/or Local Approvals.)

**FLOW RATE vs PRESSURE**

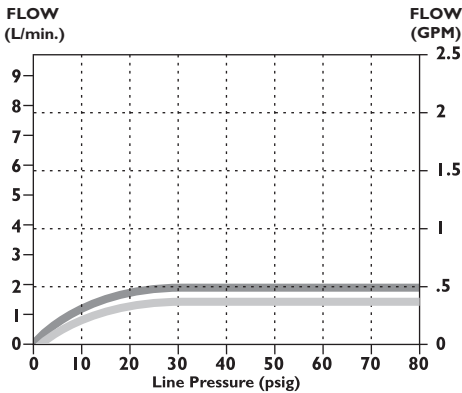

**Spout Outlets**  
 — No. 5 Outlet      — No. 9 Outlet

**86T1153**

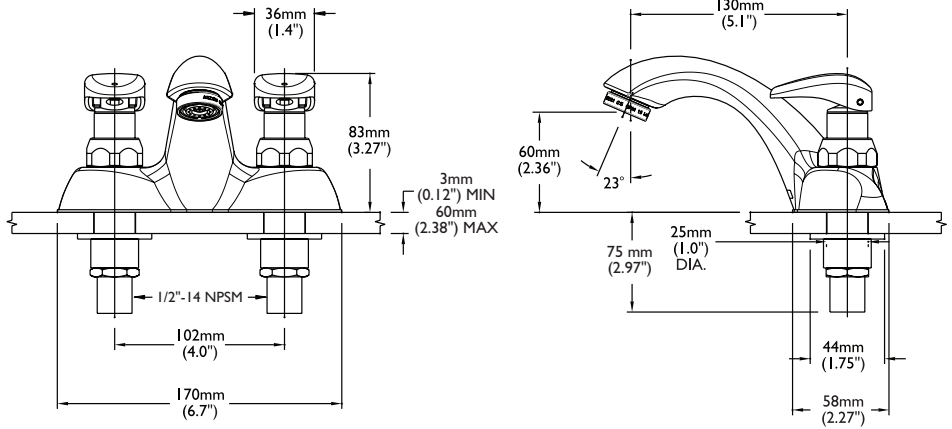

INLET FOR 3/8" OR 1/2" FLEXIBLE RISER  
OR 1/2-14 NPSM COUPLING NUT (NOT SUPPLIED)

**OPEN GRID STRAINER**  
(supplied with Product Variation 0)

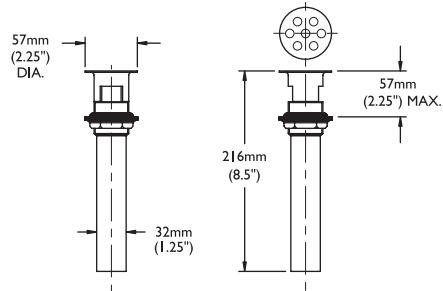

Note: Measurements may vary ± 6mm (0.25")

Refer to [www.specselect.com](http://www.specselect.com) for individual models.

Note: Use this page front and back as a product submittal sheet.